

### Fixed-Focal Lenses for Machine Vision Use: Full 5-Mega-Pixel Resolution for 1/1.2" and 2/3" Imagers In a Compact Size of $\phi$ 29mm

- 1/1.2" 8mm F/2.4 (Model: M112FM08)    ■ 1/1.2" 12mm F/2.0 (Model: M112FM12)
- 1/1.2" 16mm F/2.0 (Model: M112FM16)    ■ 1/1.2" 25mm F/1.8 (Model: M112FM25)
- 1/1.2" 35mm F/2.1 (Model: M112FM35)    ■ 1/1.2" 50mm F/2.8 (Model: M112FM50)
- 1/1.2" 75mm F/3.5 (Model: M112FM75)



For

**IMX174** 1/1.2  
2-Mega

**IMX249** 1/1.2  
2-Mega

**IMX250** 2/3  
5-Mega

**IMX264** 2/3  
5-Mega

For

**5.86 $\mu$ m**

**3.45 $\mu$ m**

#### Main Features

##### > Unrivalled High-Contrast and High-Resolution in the Industry

- Compatible with both 5.86 $\mu$ m pixel-pitch 1/1.2" imagers and 3.45 $\mu$ m pixel-pitch 2/3" imagers  
Equivalent resolution of full 5-mega-pixels
- Industry-leading resolution and contrast in  $\phi$ 29mm machine-vision lenses.
- First-class performance in all different focal lengths of the models.

##### > Advanced Coating Technology and State-of-the-Art Optical Design





- Both state-of-the-art optics and advanced coating technologies assure distinguished optical performance, particularly in contrast and resolution, and superb optical transmittance for crisp and clear images.



##### > High-Quality Imaging at Close-Shooting Distances

- Lenses assure high-quality imaging at close-shooting distances often used.

##### > Other Features

- Critical performance in resolution is thoroughly examined from the center to the periphery of images, assuring high-contrast and high-resolution without unbalanced blurring.
- Rotational torque is increased to improve maneuverability for focusing and iris adjustment.  
Lock-screw positions are now selectable from four locations, assisting easier installation for users.
- An embedding-type setscrew is included as a standard accessory, making the lens barrel free of a screw-head to enable installation in a compact space.

Model		M112FM08	M112FM12	M112FM16	M112FM25	
						
Imager Size		1/1.2"				
Mount Type		C				
Focal Length		8mm	12mm	16mm	25mm	
Aperture Range		F/2.4 ~ 16	F/2.0 ~ 16		F/1.8 ~ 16	
Field of View Angle (H x V)	1/1.2"	(4:3)	70.3°×54.9°	49.2°×37.6°	37.4°×28.4°	24.1°×18.2°
		(16:9)	75.3°×45.6°	53.2°×30.6°	40.5°×22.3°	26.2°×15.0°
	2/3"	(4:3)	59.5°×45.8°	40.9°×31.1°	31.0°×23.4°	19.9°×15.0°
		(16:9)	64.0°×37.8°	44.4°×25.5°	33.7°×19.2°	21.7°×12.3°
Focusing Range		0.1m ~ ∞				
Operation	Focus	Manual w/lock				
	Iris	Manual w/lock				
Filter Size		M35.5 P=0.5	M27 P=0.5			
Wave Length		Visible Light				

Model		M112FM35	M112FM50	M112FM75	
					
Imager Size		1/1.2"			
Mount Type		C			
Focal Length		35mm	50mm	75mm	
Aperture Range		F/2.1 ~ 16	F/2.8 ~ 16	F/3.5 ~ 16	
Field of View Angle (H x V)	1/1.2"	(4:3)	17.3°×13.1°	12.2°×9.2°	8.1°×6.1°
		(16:9)	18.8°×10.7°	13.2°×7.5°	8.9°×5.0°
	2/3"	(4:3)	14.3°×10.7°	10.0°×7.5°	6.7°×5.0°
		(16:9)	15.5°×8.8°	10.9°×6.16°	7.3°×4.1°
Focusing Range		0.2m ~ ∞	0.3m ~ ∞	0.7m ~ ∞	
Operation	Focus	Manual w/lock			
	Iris	Manual w/lock			
Filter Size		M27 P=0.5			
Wave Length		Visible Light			

Imager Size Example

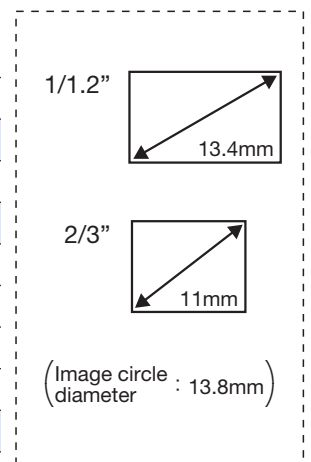

**TAMRON CO., LTD.** <http://www.tamron.biz/en/>  
 1385, Hasunuma, Minuma-ku, Saitama-shi, Saitama 337-8556 JAPAN  
 Tel: +81-48-684-9129 Fax: +81-48-683-8594

**TAMRON USA, INC.** <http://www.tamron-usa.com>  
 10 Austin Boulevard, Commack, NY 11725, USA Tel: +1-631-858-8400 Fax: +1-631-543-3963

**TAMRON Europe GmbH.** <http://www.tamron.de>  
 Robert Bosch-Str. 9, 50769 Cologne, GERMANY Tel: +49-221-970325-0 Fax: +49-221-970325-4

**TAMRON INDUSTRIES (HONG KONG) LIMITED** <http://www.tamron.com.hk>  
 Unit 908, 9/F, Elite Centre, 22 Hung To Road, Kwun Tong, Kowloon, Hong Kong Tel: +852-2721-7797 Fax: +852-2620-1631

**TAMRON (Russia) LLC.** <http://www.tamron.ru>  
 Unikon Business Center 5F No. 9, Plekhanova Street 4a, Moscow, 11123, Russian Federation  
 Tel: +7-495-970-0112 Fax: +7-495-970-0112

**TAMRON INDIA PRIVATE LIMITED** <http://www.tamron.in>  
 801, 8th Floor, Time Tower, M.G Road, Sector-28, Gurgaon-122002, Haryana, India  
 Tel: +91-124-41-168-12 Fax: +91-124-40-822-72



**Management on Quality and Environment :**

Tamron is certified with international standards: ISO 9001 for quality and ISO 14001 for environmental management at its headquarters, domestic sales offices, China plant as well as three production facilities in Aomori, Japan, and is fully committed to striving for continued and sustainable improvement at all levels and facets of its business operations.