

M117FM12

Imager Size		1/1.7"
Mount Type		C
Focal Length		12 mm
Aperture Range		F/2.4 ~ F/16
Field of View Angle (Horizontal x Vertical)	1/1.7"	34.3° × 25.9°
	1/1.8"	33.7° × 22.9°
	1/2"	29.3° × 22.1°
	1/3"	22.1° × 16.6°
Focus Range		0.1 m ~ ∞ (Recommended Shooting Distance 0.3m)
Operation	Focus	Manual w/lock
	IRIS	Manual w/lock
Filter Size		M27 P=0.5
Wave Length		Visible Light
TV Distortion		-0.42% (*)
Weight		40 g
Operating Temperature		-20°C ~ +60°C

Drawing

* 設計値/Design Value

Focus rotation angle: 71.4 deg
Iris rotation angle: 52.8 deg

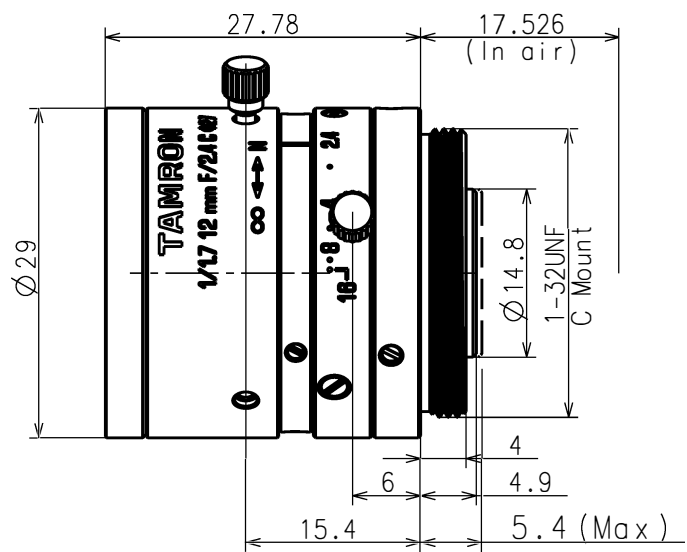
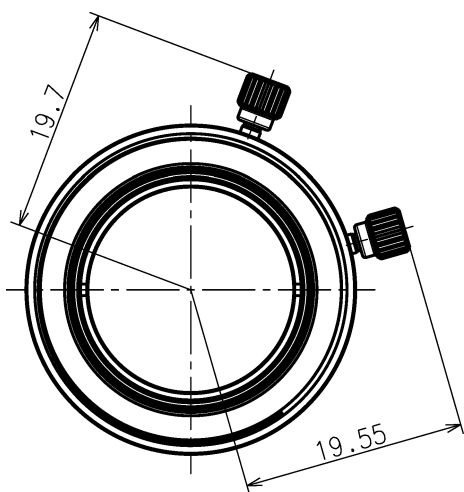

Specification and design subject to change without any notice.