

LM25JC10M

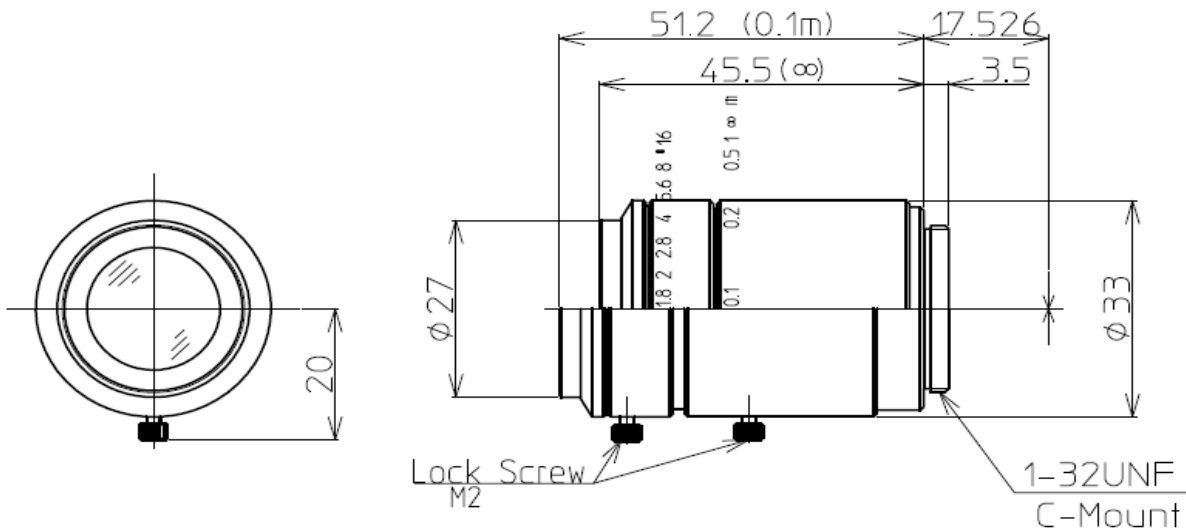

2/3" 1.8/25mm C		1/2"	1/3"
FOCAL LENGTH		f=25mm	
MAX. DIAMETER (RATIO)		F=1:1.8~16	
ELEMENT		9 ELEMENTS 10 GROUPS	
PICTURE SIZE		6.6x8.8mm	3.6x4.8
ANGLE	VER. ANGLE	15.1°	8.2°
	HOR. ANGLE	20.0°	11.0°
	DIA. ANGLE	24.9°	13.7°
DISTORTION (TV)		-0.09%	-
SHOOTING RANGE AT MINIMUM FOCUS DISTANCE	VER.	27.5mm	15.0mm
	HOR.	36.7mm	20.0mm
	DIA.	46.0mm	25.0mm
MINIMUM FOCUS DISTANCE		0.1m	
FLANGE BACK		17.526mm in air	
BACK FOCUS		17.9mm in air	
FILTER SCREW SIZE		M25.5x0.5	
FRONT/REAR EFFECTIVE DIA.		FRONT ϕ 18.4mm	REAR ϕ 18.4mm
MOUNT		C-MOUNT	
EXIT PUPIL		-84.4	
TEMPERATURE RANGE		-10~+50° C	
STORAGE TEMPERATURE RANGE		-20~+60° C	
RESOLUTION CENTER/CORNER		CENTER 200lp/mm CORNER 160lp/mm	
LENS COATING		WIDE BAND MULTI COATING	
WEIGHT		95 g	