

BMC-S129

High Sensitivity 12x Zoom Module

LVDS EX-SDI CVBS



Features

- 1/2" 2MP Sony CMOS sensor
- 1080p 60fps/30fps, 1080i 60fps, 720p 60fps/30fps
- 12x Optical Zoom(7mm~84mm) & 32x Digital Zoom
- F1.5(wide) ~ F1.9(tele)
- Day & Night(ICR)
- Real-time True WDR(DOL)
- Digital Noise Reduction(2D+3D)
- Digital Image Stabilization
- Privacy Mask Function
- High Light Compensation
- Intelligent Motion Detection
- Defog Function
- Supports VISCA, Pelco-D/P Protocol
- Video Out : LVDS, EX-SDI 1.0, EX-SDI 2.0, EX-SDI 2.1, CVBS

Dimensions

Unit : mm

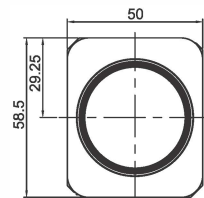

FRONT

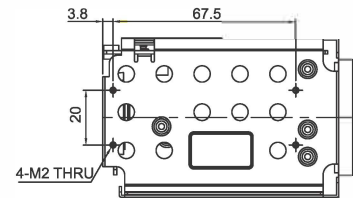

LEFT SIDE

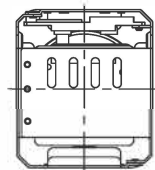

BACK

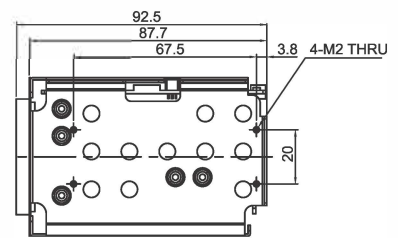

RIGHT SIDE

Field of View

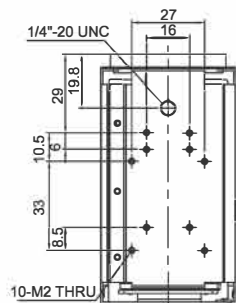
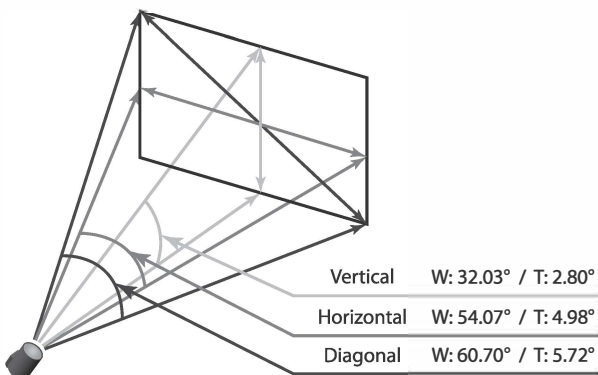

BOTTOM

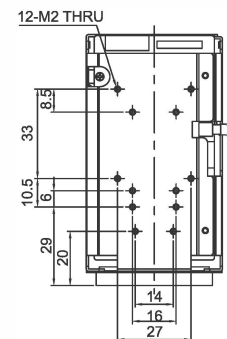

TOP

Specifications

BMC-S129				
Image Sensor	1/2" Sony CMOS Sensor			
Total Pixels	1,952(H) x 1,113(V) = 2.17M Pixels			
Active Pixels	1,937(H) x 1,097(V) = 2.12M Pixels			
Scanning System	Progressive Scan			
Sync. System	Internal			
Resolution	Digital : 1080p/60(50)fps, 1080i/60(50)fps, 1080p/30(25)fps, 720p/60(50)fps, 720p/30(25)fps Analog : 700TVL			
Min. Illumination	Color(1/30s) : 0.01 lux, BW(1/30s) : 0.002 lux Color DSS(1/1s) : 0.001 lux, BW DSS(1/1s) : 0.0002 lux			
Video Output	HD : LVDS, EX-SDI 1.0, EX-SDI 2.0, EX-SDI 2.1 Analog SD : CVBS			
S/N Ratio	more than 50dB(AGC off)			
Lens Type	12x Day & Night Zoom Lens			
Zoom Ratio	Optical 12x, Digital 32x Zoom			
Focal Length	f = 7.0mm ~ 84mm			
Aperture Ratio	F1.5 (wide) ~ F1.9 (tele)			
Angle Of View(D, H, V)	Wide	60.70°	54.07°	32.03°
	Tele	5.72°	4.98°	2.80°
AF Mode	Auto / One Push / Manual			
Min. Distance	0.1 / 1.5 / 3.0 / 5.0 / 10.0 m			
Lens Refresh	One Push / 1 ~ 10Day			
Digital Zoom	Off / MAX 2x ~ 32x			
Exposure	Auto / Iris.P / Shut.P / Manual			
Gain Control(AGC)	0 ~ 10 steps			
Shutter Speed	1/30(25) ~ 1/60,000 sec			
Iris	0 ~ 20 steps			
Digital Slow Shutter(DSS)	Off / 2x / 4x / 8x / 16x / 32x / (64x : 60 or 50 fps mode only)			
Brightness	0 ~ 20 steps			
WDR/BLC	Off / WDR / BLC			
Day&Night	Auto / Day / Night / Ext-in			
White Balance	Auto / One Push / Manual / Indoor / Outdoor / Auto-Ext			
HLC	Off / On / Night Only			
DNR	Auto / Off / Low / Middle / High			
Mirror	Off / H / V / H&V			
Sharpness	0 ~ 10 steps			
ACE	Off / Low / Middle / High			
Defog	Off / On(Auto / Manual)			
Privacy Mask	Max. 24 Areas			
Motion Detection	Max. 3 Areas			
Defect Detection	Off / On			
System	NTSC / PAL			
Communication	Baud Rate : 2400 / 4800 / 9600 / 19200 / 38400 / 57600 / 115200 Protocol : VISCA / Pelco-D / Pelco- P / Update			
Language	English / Simplified Chinese / Traditional Chinese / Japanese			
Power Source	9V to 15V DC			
Power Consumption	500mA			
Power Input	Connector			
Video Output	Connector			
Storage Temperature	-20℃ ~ +60℃ (Humidity : 0%RH ~ 90%RH)			
Operating Temperature	-10℃ ~ +50℃ (Humidity : 0%RH ~ 90%RH)			
Dimensions	50(W) x 58.5(H) x 92.5(D)			
Weight	250g			

Pin Assignment

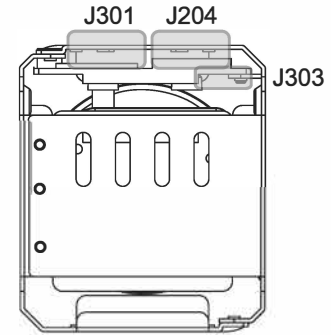

J301	
1	TXOUT3+
2	TXOUT3-
3	TXCLKOUT+
4	TXCLKOUT-
5	TXOUT2+
6	TXOUT2-
7	TXOUT1+
8	TXOUT1-
9	TXOUT0+
10	TXOUT0-
11	GND
12	TxD CMOS 5 V
13	RxD
14	DC+12V IN
15	DC+12V IN
16	DC+12V IN
17	DC+12V IN
18	DC+12V IN
19	GND
20	GND
21	TXOUT7+
22	TXOUT7-
23	TXOUT6+
24	TXOUT6-
25	EXSDI+
26	EXSDI-
27	TXOUT5+
28	TXOUT5-
29	TXOUT4+
30	TXOUT4-

J302	
1	GND
2	TxD
3	RxD
4	NC
5	GND
6	NC
7	GND
8	ADKEY
9	NC
10	D/N-IN
11	NC
12	MD-OUT
13	RS 485-DIR
14	NC
15	GND
16	DC+5V OUT
17	GND
18	VBS-OUT
19	GND
20	DC+12V IN
21	DC+12V IN
22	DC+12V IN
23	DC+12V IN
24	DC+12V IN

Ref 05002HR-24J05(YEONHO)

J303	
1	GND
2	VBS-OUT

Ref 12505WR-02(YEONHO)

Ref USL00-30L-C(KEL Cop.)

* Design and specifications are subject to change without notice.