

产品技术规格书 (Product Technical Specification)

No.	名称 (Name)	规格 (Specification)	No.	名称 (Name)	规格 (Specification)	
1	型号 (Model)	AZURE-2528CF	11	视场角 F.O.V(DxVxH)	2/3(1:1) 2/3(5:4) 1/1.8(5:4) 1/1.8(4:3)	
2	物料代码 (Material Code)	3. A01. 010147-A			D	26.76 26.76 20.02 20.02
3	靶面格式 (Image Format)	2/3"			H	18.92 20.89 15.63 16.02
4	分辨率 (Resolution)	250 lp/mm			V	18.92 16.72 12.51 12.01
5	焦距 (Focal Length)	25mm	12	接口 (Mount)	C	
6	后截距 (Back Focus)	12.98mm	13	适用物距 (Suitable Distance)	0.15~∞m	
7	F值 (F/ No.)	2.8	14	外形尺寸 (Dimension)	φ33×46.5mm	
8	光圈 (Iris Type)	Manual	15	重量 (Weight)	g	
9	畸变 (Distortion)	<-0.46%	16	工作温度 (Operating Temperature)	-20~+65℃	
10	通光口径 (Lens Effective Diameter)	前面 (Front)	φ18.82mm	17	滤镜尺寸 (Filter Thread)	M30.5×0.5
		后面 (Back)	φ15.10mm	18	光学总长 (TTL)	56.7mm

Size:

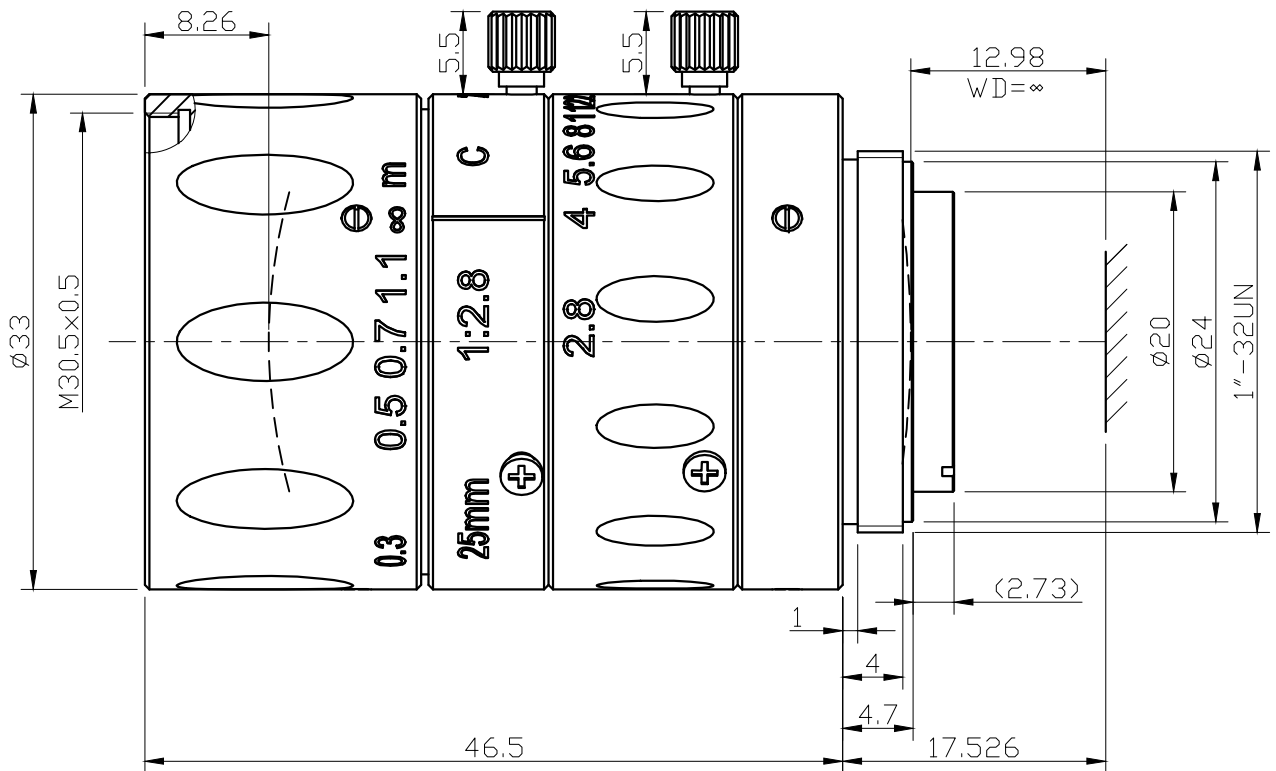

Unit:mm

Draw	Check	Recheck	Approval	福建浩蓝光电有限公司 AZURE Photonics Co.,Ltd